

# Vane pumps type PFE-31, PFE-41, PFE-51

fixed displacement - cartridge design

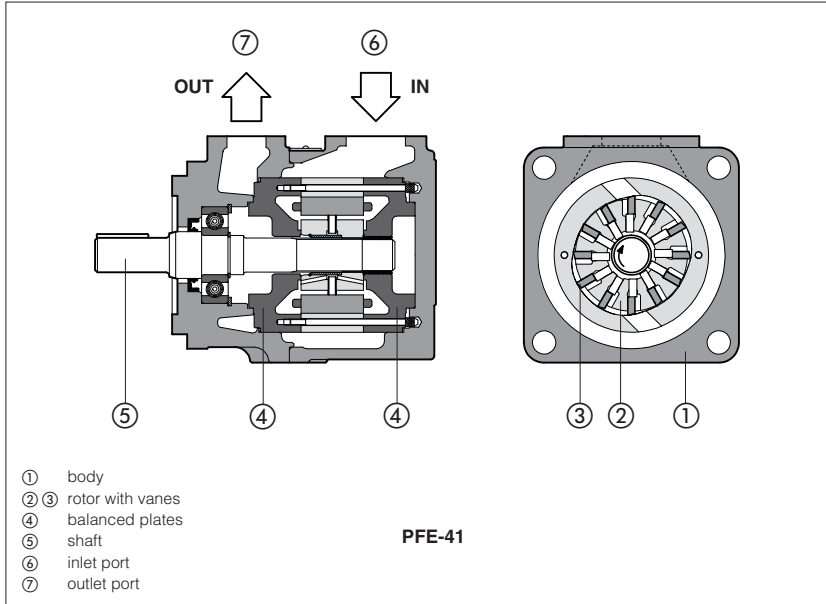

PFE are fixed displacement-twelve-vane pumps, ② ③ cartridge design with integral hydraulic balancing ④ for high pressure operation and long service life with low noise level.

Suitable for hydraulic oils according to DIN 51524... 535 or synthetic fluids having similar lubricating characteristics.

These pumps are available as single, multiple or with through-shaft configuration.

Mounting according to SAE J744 standard.

Easy installation as inlet and outlet ports can be assembled in any of four relative positions.

Easy maintenance as the pumping cartridge can be replaced in a few minutes.

Wide variety of displacements up to 150 cm<sup>3</sup>/rev.

Max pressure 210 bar.

## 1 MODEL CODE

<b>PFE</b>	<b>X2</b>	<b>- 31</b>	<b>036</b>	<b>/31028</b>	<b>/ 1</b>	<b>D</b>	<b>T</b>	<b>**</b>	<b>/*</b>
Fixed displacement vane pump									Synthetic fluids: <b>WG</b> = water-glycol <b>PE</b> = phopsphate ester
<p>Additional suffix for multiple pumps:  <b>X2</b> = double pump composed of single vane pumps  <b>X3</b> = triple pump composed of single vane pumps</p> <p>Eventual suffix for pumps with through shaft:  <b>XA</b> = for coupling one PFE-31  <b>XB</b> = for coupling one PFE-41 (only for PFE-41 and PFE-51)  <b>XC</b> = for coupling one PFE-51 (only for PFE-51)  <b>XO</b> = with through shaft, without rear flange</p> <p>Note: multiple pumps are assembled in decreasing order of size. See also tab. A190.</p>							<p>Port orientation, see section ⑤:  <b>T</b> = standard  <b>U, V, W</b> = on request</p>		
<p>Size, see section ②:  <b>31, 41, 51</b></p>							<p>Direction of rotation (viewed from the shaft end):  <b>D</b> = clockwise (supplied standard if not otherwise specified)  <b>S</b> = counterclockwise                  Note: PFE are not reversible</p>		
<p>Displacement [cm<sup>3</sup>/rev], see section ②                  for PFE 31: <b>016, 022, 028, 036, 044</b>                  for PFE 41: <b>029, 037, 045, 056, 070, 085</b>                  for PFE 51: <b>090, 110, 129, 150</b></p>							<p>Drive shaft, see section ⑥ and ⑦:                  cylindrical, keyed for single and multiple pump (only first position)  <b>1</b> = standard  <b>2</b> = long version (only for PFE-41 and PFE-51)  <b>3</b> = for high torque applications                  splined  <b>5</b> = for single and multiple pumps (any position)  <b>6</b> = for single and multiple pumps (only first position)  <b>7</b> = for second and third position in multiple pumps } only for PFE-181 and PFE-41</p>		
<p>Only for multiple pumps PFE<sup>**</sup>: type of second (and third) pump</p>									

## 2 OPERATING CHARACTERISTICS at 1450 rpm (based on mineral oil ISO VG 46 at 50°C)

Model	Displacement cm <sup>3</sup> /rev	Max pressure	Speed range rpm (2)	7 bar (3)		70 bar (3)		140 bar (3)		210 bar (3)	
				l/min	kW	l/min	kW	l/min	kW	l/min	kW
PFE-31016	16,5	210 bar (1)	800-2800	23	0,5	21	3	19	5	16	8,3
PFE-31022	21,6			30	0,6	28	4	26	7	23	10,8
PFE-31028	28,1			40	0,8	38	5,5	36	10	33	14
PFE-31036	35,6			51	1	49	7	46	12,5	43	17,8
PFE-31044	43,7			63	1,3	61	8	58	15,5	55	22
PFE-41029	29,3			41	0,8	39	5,5	37	10	34	14,7
PFE-41037	36,6			52	1	50	7	48	12,5	45	18,3
PFE-41045	45,0			64	1,3	62	8,5	60	16	57	22,6
PFE-41056	55,8			80	1,6	78	11	75	21	72	28
PFE-41070	69,9			101	2	98	13,5	95	26	91	35
PFE-41085	85,3			124	2,4	121	16	118	32	114	43
PFE-51090	90,0			128	2,7	124	17	119	33	114	45
PFE-51110	109,6		157	3,2	152	21	147	40	141	55	
PFE-51129	129,2		186	3,7	180	25	174	47	168	65	
PFE-51150	150,2		215	4,2	211	29	204	55	197	75	

(1) Max pressure is 160 bar for /PE and /WG versions  
 (2) Max speed is 1800 rpm for /PE versions; 1500 rpm for /WG versions  
 (3) Flow rate and power consumption are proportional to the rotation speed

### 3 MAIN CHARACTERISTICS OF VANE PUMPS TYPE PFE-\*1

Installation position	Any position.	
Loads on the shaft	Axial and radial loads are not allowed on the shaft. The coupling should be sized to absorb the power peak.	
Ambient temperature	from -20°C to +70°C	
Fluid	Hydraulic oil as per DIN 51524...535; for other fluids see section 1	
Recommended viscosity	max at cold start max at full power during operation min at full power	800 mm <sup>2</sup> /s 100 mm <sup>2</sup> /s 24 mm <sup>2</sup> /s 10 mm <sup>2</sup> /s
Fluid contamination class	ISO 19/16 (filters at 25 µm value with β <sub>25</sub> ≥ 75 recommended)	
Fluid temperature	-20°C +60°C	-20°C +50°C (/WG seals)    -20°C +80°C (/PE seals)
Recommended pressure on inlet port	from -0,15 to 1,5 bar for speed up to 1800 rpm; from 0 to +1,5 bar for speed over 1800 rpm	

### 4 DIAGRAMS (based on mineral oil ISO VG 46 at 50°C)

#### 1 = Torque versus pressure diagram

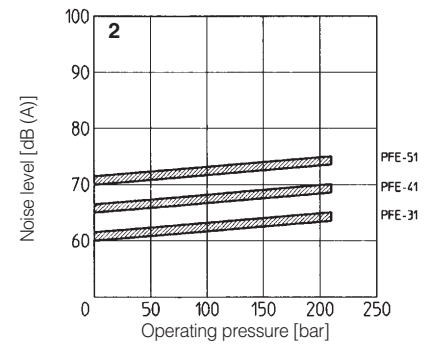
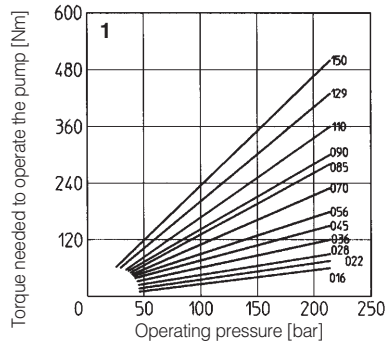

**2 = Ambient noise levels** measured in compliance with ISO 4412-1 oleohydraulics -Test procedure to define the ambient noise level - Pumps  
Shaft speed: 1450 rpm.

#### PFE-31:

**3 = Flow versus speed diagram** with pressure variation from 7 bar to 210 bar.

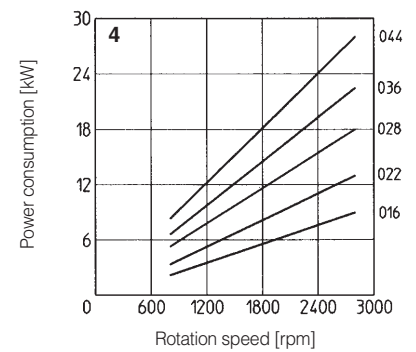
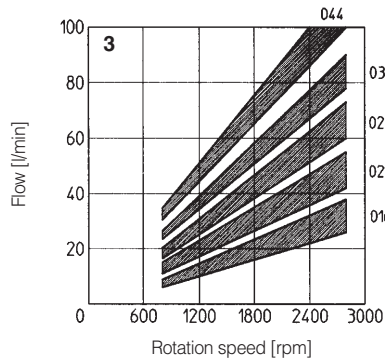

**4 = Power consumption versus speed diagram** at 140 bar. Power consumption is proportional to operating pressure.

#### PFE-41:

**5 = Flow versus speed diagram** with pressure variation from 7 bar to 210 bar.

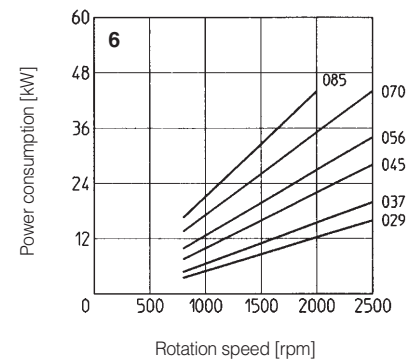
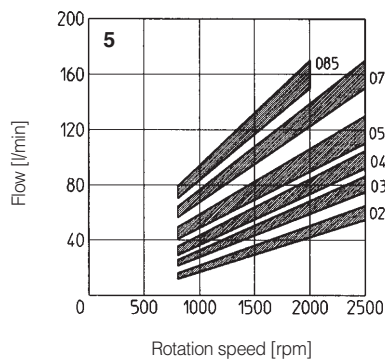

**6 = Power consumption versus speed diagram** at 140 bar. Power consumption is proportional to operating pressure.

#### PFE-51:

**7 = Flow versus speed diagram** with pressure variation from 7 bar to 210 bar.

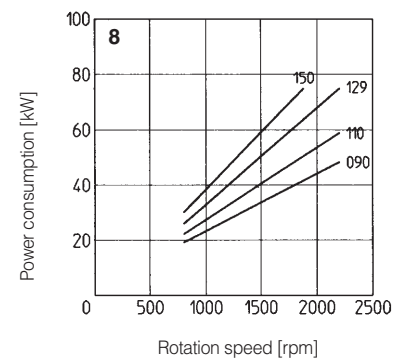
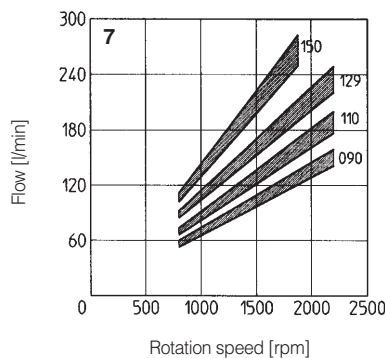

**8 = Power consumption versus speed diagram** at 140 bar. Power consumption is proportional to operating pressure.

## 5 PORT ORIENTATION

Single pumps can be supplied with oil ports oriented in different configuration in relation to the drive shaft, as follows (viewed from the shaft end);  
**T** = inlet and outlet ports on the same axis (standard)  
**U** = outlet orientated 180° with respect to the inlet  
**V** = outlet oriented 90° with respect to the inlet  
**W** = outlet oriented 270° with respect to the inlet  
 In multiple pumps inlet ports and outlet ports are in line.  
 Ports orientation can be easily changed by rotating the pump body that carries inlet port.

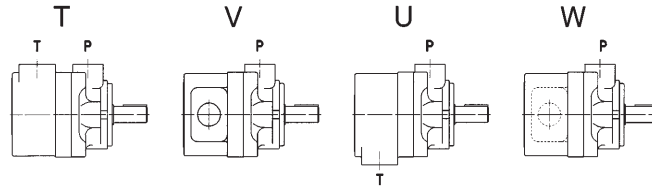

## 6 DRIVE SHAFT

### CYLINDRICAL SHAFT KEYED

- 1 = for single and multiple pumps (only first position) supplied as standard if not specified in the model code
- 2 = for single and multiple pumps (only first position) long version (only for PFE-41 and PFE-51)
- 3 = for single and multiple pumps (only first position) for high torque applications

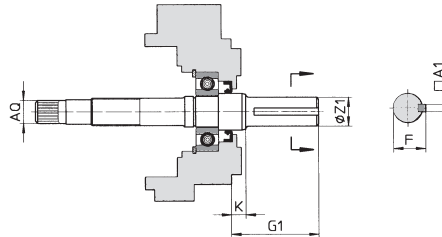

Model	Keyed shaft type 1 (standard)						Keyed shaft type 2						Keyed shaft type 3					
	A1	F	G1	K	ØZ1	Ø AQ	A1	F	G1	K	ØZ1	Ø AQ	A1	F	G1	K	ØZ1	Ø AQ
PFE-31	4,78	21,11	56,00	8,00	19,05	SAE 16/32-9T	-	-	-	-	-	-	4,78	24,54	56,00	8,00	22,22	SAE 16/32-9T
	4,75	20,94			19,00								4,75	24,41			22,20	
PFE-41	4,78	24,54	59,00	11,40	22,22	SAE 32/64-24T	6,36	25,03	71,00	8,00	22,22	SAE 32/64-24T	6,38	28,30	78,00	11,40	25,38	SAE 32/64-24T
	4,75	24,41			22,20		6,35	24,77			22,20		6,35	28,10			25,36	
PFE-51	7,97	35,33	73,00	14	31,75	SAE 16/32-13T	7,95	35,33	84,00	8,10	31,75	SAE 16/32-13T	7,97	38,58	84,00	14	34,90	SAE 16/32-13T
	7,94	35,07			31,70		7,94	35,07			31,70		7,94	38,46			34,88	

### SPLINED SHAFT

- 5 = for single and multiple pumps (any position)
  - for PFE-31 according to SAE A 16/32 DP, 9 teeth;
  - for PFE-41 according to SAE B 16/32 DP, 13 teeth;
  - for PFE-51 according to SAE C 12/24 DP, 14 teeth;
- 6 = for single and multiple pumps (only first position)
  - for PFE-31 and PFEX\*-31 according to SAE B 16/32 DP, 13 teeth;
  - for PFE-41 and PFEX\*-41 according to SAE C 12/24 DP, 14 teeth;
- 7 = for second and third position pump in multiple configuration:
  - for PFEX\*-31 according to SAE B 16/32 DP, 13 teeth;
  - for PFEX\*-41 according to SAE C 12/24 DP, 14 teeth;

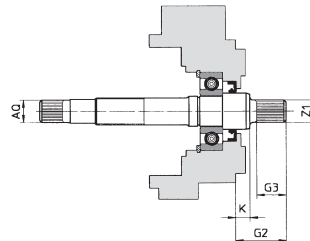

Model	Splined shaft type 5					Splined shaft type 6					Splined shaft type 7				
	G2	G3	K	Z1	Ø AQ	G2	G3	K	Z1	Ø AQ	G2	G3	K	Z1	Ø AQ
PFE-31	32,00	19,50	6,50	SAE 16/32-9T	SAE 16/32-9T	41,00	28	8,00	SAE 16/32-13T	SAE 16/32-9T	32,00	19	8,00	SAE 16/32-13T	SAE 16/32-9T
PFE-41	41,25	28	8,00	SAE 16/32-13T	SAE 32/64-24T	55,60	42	8,00	SAE 12/24-14T	SAE 32/64-24T	41,60	28	8,00	SAE 12/24-14T	SAE 32/64-24T
PFE-51	56,00	42	8,10	SAE 12/24-14T	SAE 16/32-13T	-	-	-	-	-	-	-	-	-	-

## 7 LIMITS OF SHAFT TORQUE

Pump model	Maximum driving torque [Nm]						Maximum torque available at the end of the through shaft [Nm]
	Shaft type 1	Shaft type 2	Shaft type 3	Shaft type 5	Shaft type 6	Shaft type 7	Any type of shaft
PFE-31	160	-	240	110	240	240	130
PFE-41	250	250	400	200	400	400	250
PFE-51	500	500	850	450	-	-	400

The values of torque required to operate the pumps are shown for each type on the "torque versus pressure" diagram at section 4.  
 In multiple pumps the total torque applied to the shaft of the first element (drive shaft) is the sum of the single torque needed for operating each single pump and it is necessary to verify that this total torque applied to the drive shaft is not higher than the values indicated in the table.

## 8 DIMENSIONS OF SINGLE PUMPS [mm]

T = inlet port  
P = outlet port

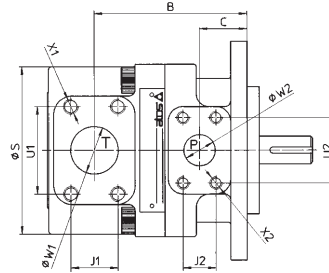
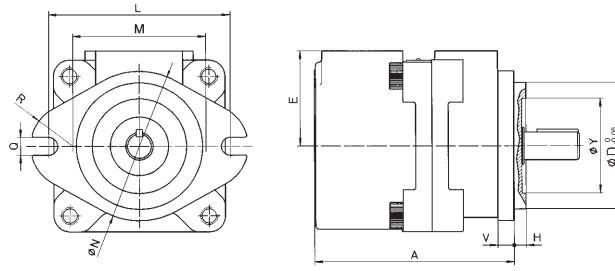

### SAE FLANGES

PFE-31: port T = 1 1/4"; port P = 3/4"

PFE-41: port T = 1 1/2"; port P = 1"

PFE-51: port T = 2"; port P = 1 1/4"

### Mass:

PFE-31 = 9 kg

PFE-41 = 14 kg

PFE-51 = 25,5 kg

SAE flanges can be supplied with the pump, see [www.scoda.it](http://www.scoda.it), tab. SK155

Model	A	B	C	ØD	E	H	L	M	ØN	Q	R
PFE-31	136	100	28	82,5	70	6,4	106	73	95	11,1	28,5
PFE-41	160	120	38	101,6	76,2	9,7	146	107	120	14,3	34
PFE-51	186,5	125	38	127	82,6	12,7	181	143,5	148	17,5	35
Model	ØS	U1	U2	V	ØW1	ØW2	J1	J2	X1	X2	ØY
PFE-31	114	58,7	47,6	10	32	19	30,2	22,2	M10X20	M10X17	47
PFE-41	134	70	52,4	13	38	25	35,7	26,2	M12X20	M10X17	76
PFE-51	160	77,8	58	15	51	32	42,9	30,2	M12X20	M10X20	76

## 9 DIMENSIONS OF PUMPS WITH THROUGH-SHAFT (FOR MULTIPLE PUMPS) [mm]

T = inlet port  
P = outlet port

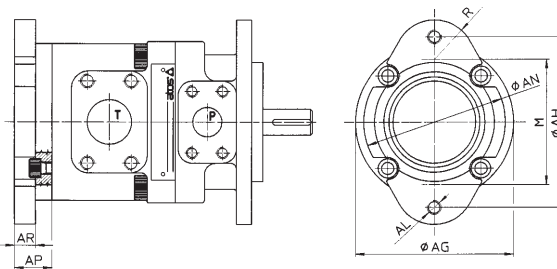
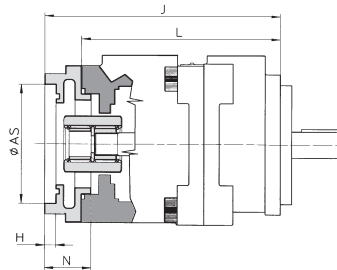

### SAE FLANGES

PFEXA-31: port T = 1 1/4"; port P = 3/4"

PFEXA-41: port T = 1 1/2"; port P = 1"

PFEXB-41: port T = 2"; port P = 1 1/4"

For other dimensions, see section 8

Model	Ø AG	Ø AH	AL	Tightening torque (Nm) <sup>(1)</sup>	Ø AN	AP	AR	Ø AS	H	J	L	M	N	R
PFEXA-31	114	106	M10X17	70	95	33	25	82,57 82,63	6,42 6,47	165,5	132,5	79	32	28,5
PFEXA-41	134	106	M10X17	70	95	23	11	82,57 82,63	6,42 6,47	194	171	73	32	28,5
PFEXB-41	134	146	M12	125	120	32	18	101,62 101,68	9,73 9,78	203	171	107	41	34
PFEXA-51	134	106	M10X17	70	95	22,7	11	82,57 82,63	6,42 6,47	206,2	183,5	73	32	28,5
PFEXB-51	134	146	M12	125	120	32	18	101,62 101,68	9,73 9,78	215,5	183,5	107	41	34
PFEXC-51	134	181	M16	300	148	46,5	30,7	127,02 127,02	12,73 12,78	230	183,5	143,5	56	35

(1) Tightening torque for screw class 12.9